







-  内开式椭圆人孔
-  **OVAL Manwaydoor inwards opening**
-  Porte Ovale avec ouverture à l'intérieur
-  Ovale Mannlochtür, schwenkbar nach innen (Innenöffnung)
-  Puerta Oval de apertura interna
-  Portella Ovale apertura interna



◆ 7028 458



规格尺寸 At temperature 50°C /122 °F

CODE	A	C	B	T	P.MAX
	mm	mm	mm	mm	bar
7028 458	446×311	6	80	3.0	1.5

如果您需要了解此产品细节，请联系我们业务部。

*1BAR ≈14.5PSI≈0.1MPA

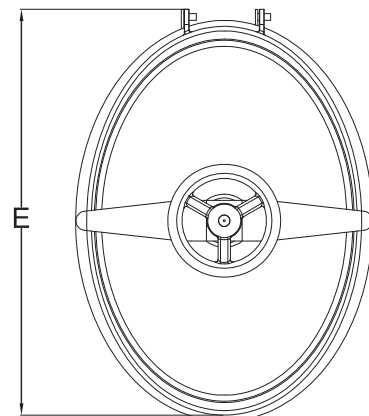
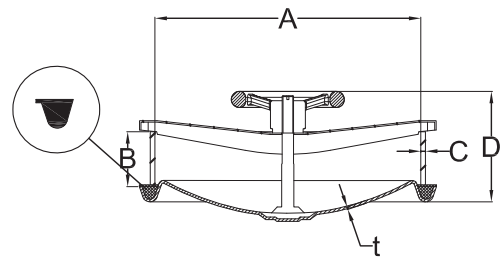

ZKD 部件分解图

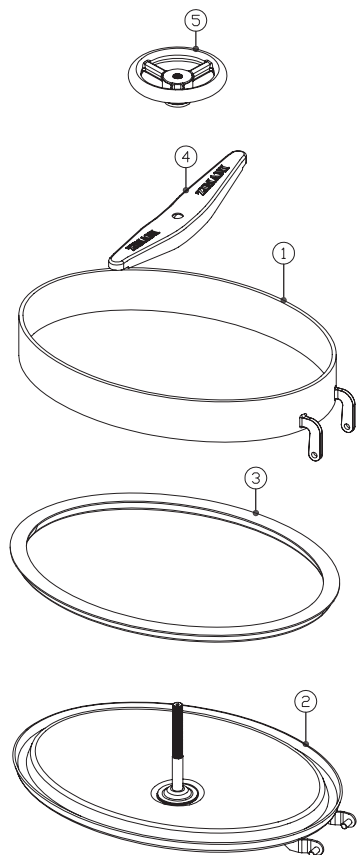

密封圈

Part No.	材质	颜色
7010-05 1	硅胶	白色
7010-05 2	EPDM	黑色
7010-05 3	氟橡胶	黑色

序号	部件名称	材质	数量
1	颈圈	1.4301/1.4404	1
2	盖子	1.4301/1.4404	1
3	密封圈	EPDM	1
4	横梁	T304	1
5	手轮	塑料/TP304	1

ZKD 证书认证

品质的流程管理通过欧洲 Bureau Veritas ISO9001认证
多年OEM品质的保证，与美国产品保持一致

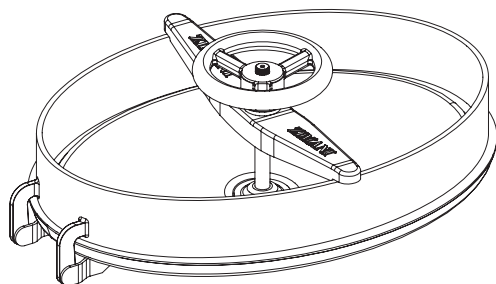

选择:

不锈钢抛光方式

抛光: 0.8 μm - 0.4 μm

喷砂

酸洗

电解

盖子 & 颈圈

盖子厚度	常规颈圈高度
2.5mm	80mm (3.15")
3.0mm	100mm (3.94")
	120mm (4.72")
	150mm (5.91")
	200mm (7.76")

颈圈、盖子的尺寸可根据您的需求定制。